

Briefing Paper

The development of test methods to assess video flame and video smoke detectors

Raman Chagger

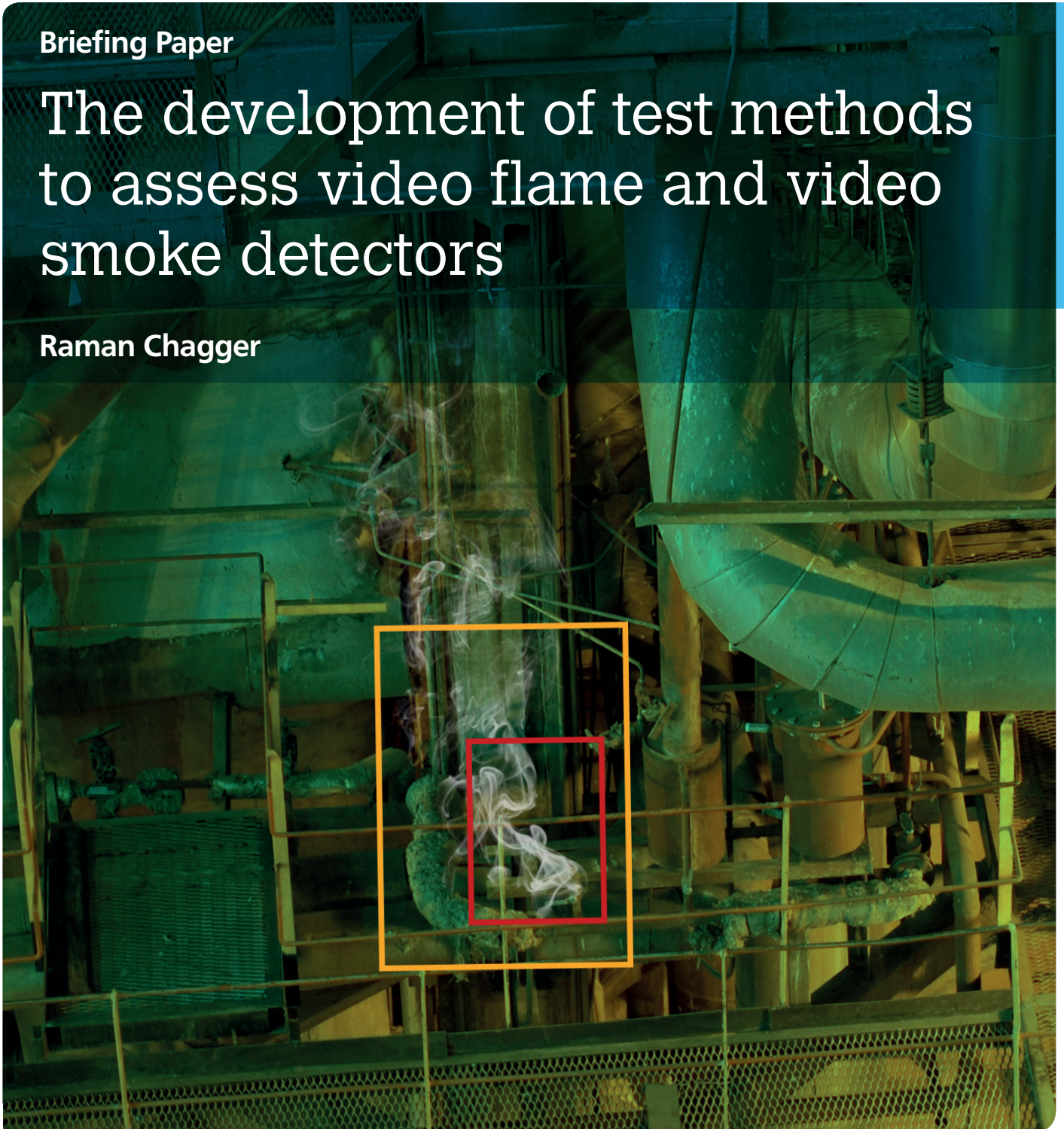

Acknowledgements

The author would like to thank the individuals, and the organisations they represent, who supported this research work by providing funding and in-kind contributions, namely:

- Maggy Baetens - Araani
- Bernard Lалуvein - B. E. H. Lалуvein Consulting Ltd.
- Mark Kendall – Fike Safety Technology Ltd.
- Paul Ottavio - Fire Fighting Enterprises
- Martin Duggan – Fire Industry Association
- Pauline Norstrom – NetVu Ltd.
- Faruk Meah - Tyco Fire Protection Products
- Peter Massingberd-Mundy - Xtralis

The author would also like to thank colleagues at BRE for their contributions towards this publication and BRE's Digital Products Team for developing the BRE video analysis tool.

Finally, the author would like to thank the BRE Trust for the funding it provided to support work on this project and this publication.

Cover photo courtesy of Araani

The logo for breTRUST, with 'bre' in green and 'TRUST' in grey.

Any third-party URLs are given for information and reference purposes only and BRE Ltd. does not control or warrant the accuracy, relevance, availability, timeliness or completeness of the information contained on any third-party website. Inclusion of any third-party details or website is not intended to reflect their importance, nor is it intended to endorse any views expressed, products or services offered, nor the companies or organisations in question. Any views expressed in this publication are not necessarily those of BRE. BRE has made every effort to ensure that the information and guidance in this publication were accurate when published, but can take no responsibility for the subsequent use of this information, nor for any errors or omissions it may contain. To the extent permitted by law, BRE shall not be liable for any loss, damage or expense incurred by reliance on the information or any statement contained herein.

Contents

Summary	2
---------	---

Abbreviations and glossary	2
----------------------------	---

Introduction	3
--------------	---

Video flame detection – bench testing	4
Methodology	4
Results	5

Video flame detection – full-scale fire testing	6
Methodology	6
Results	7

Video smoke detection – bench testing	8
Methodology	8
Results	11

Video smoke detection – full-scale fire testing	12
Methodology	12
Results	13

Summary of Findings	18
---------------------	----

Conclusions	19
-------------	----

References	20
------------	----

Summary

Video fire detectors are increasingly being used to detect the signatures of fires in areas where traditional detectors may be inappropriate or when a quicker response is needed or where visual verification is required. Video fire detectors use cameras to monitor large protected spaces, and sophisticated analytical algorithms to process the images obtained and identify the presence of smoke and/or flame. Currently, due to their complexity and variable functionality, there are no defined and robust methods of assessing the capabilities of these detectors for testing and certification purposes.

There has been a significant amount of fundamental research work on the capabilities and potential applications of video fire detectors [1, 2, 3]. The current study differs from the previous work in that the aim of this research was to develop methodologies to actively test these systems. It used the principles from the EN 54 series of standards for assessing fire detectors as the basis for testing video flame and video smoke detection. Tests were performed on video fire detectors to develop repeatable test methods and propose criteria from which the performance capabilities of these products could be determined. The end goal of this work was to develop a product test standard that could be used to test and certificate video fire detectors.

BRE Global and the Fire Industry Association (FIA) had been working on the development of test methodologies for these technologies

for many years and it was identified that the greatest obstacle to establishing a suitable test method for video fire detectors was the lack of benchmark tests of basic performance. These are required in order to perform the fundamental tests of repeatability, reproducibility and environmental testing defined in the EN 54 series of standards. Additionally, operational performance tests are needed to verify video fire detectors' absolute capabilities in detecting the fires anticipated in the service environment, to identify their performance limitations.

A collaborative research programme with manufacturers of video fire detectors, was developed to identify benchmark and operational performance test methods for two technology types – Video Flame Detectors (VFD) and Video Smoke Detectors (VSD), both operating in the visible range.

This work has successfully progressed and developed methodologies for assessing the performance of VFD and VSD. This briefing paper summarises the work of three private collaborative BRE studies [4, 5, 6]. The knowledge gained during this research work will support the various standardisation processes and contribute to the future development of related standards and codes.

Abbreviations and Glossary

The abbreviations listed and the glossary are compiled from terms used in this publication. The descriptions in the glossary are not intended to be comprehensive, but to help the reader understand the meaning of terms as they are used in this briefing paper.

Abbreviations

ASD	Aspirating Smoke Detector
CoP	Code of Practice
CSV	Comma-Separated Values
FIA	Fire Industry Association
FoV	Field of View
IR	Infrared
OBSD	Optical Beam Smoke Detector
RMSE	Root Mean Square Error
TF2	Smouldering Wood Test Fire
TF3	Smouldering Cotton Wick Test Fire
TF4	Flaming Polyurethane Test Fire
TF5	Flaming Liquids Test Fire
UV	Ultraviolet
VFD	Video Flame Detectors
VSD	Video Smoke Detectors

Glossary

EN 54 – the series of mandatory European Standards that specify requirements, test methods and performance criteria for all components of a fire detection and fire alarm system.

Repeatability – a measure of how repeatable the response of a detector is when tested a number of times to exactly the same test method.

Reproducibility – a measure of how reproducible the response of multiple detectors are when tested to exactly the same test method.

Root Mean Square Error – a metric that measures individual pixel changes between two images from a video to give a measure of total percentage change between them.

Video Flame Detectors – detectors that recognise the flame signature of a fire

Video Smoke Detectors – detectors that recognise the smoke signature of a fire

Introduction

Detection of fires in large open spaces has traditionally been provided by optical beam smoke (OBSD), aspirating smoke (ASD) or flame detectors that can cover large volumes. Generally, OBSDs and ASDs, located close to the ceiling offer significant advantages, as they integrate the smoke contributions over an area, thereby providing a faster response than an array of standard optical point type smoke detectors. A lot of work has been done in this area to identify the most appropriate sensitivity levels for these types of detectors [7] in such spaces.

Flame detectors typically operate by detecting the infrared (IR) or ultraviolet (UV) radiation from a fire, which usually occurs when a fire is established. These types of detectors usually have a conical field of view (FoV) and, depending on their sensitivity, can detect standard test fires at distances of up to 25 m as defined in the EN 54-10:2002 Fire detection and fire alarm systems Part 10: Flame detectors [8] standard. An EN 54-10 approved flame detector (see example in Figure 1) will detect the presence of a flame anywhere in its (typically) 90° cone FoV and within range. Some manufacturers have incorporated additional functionality to effectively split the FoV into zones, permitting identification of the zone in which a fire is located.



Figure 1: Example of an EN 54-10 approved flame detector (photo courtesy of Tyco Fire Protection Products)

Around 15 years ago video fire detectors emerged as a new fire detection solution to provide supplementary detection over large volumes (such as atria or warehouses) for life and property protection. They rapidly detect the presence of a fire by identifying the signature of smoke and/or flame present in the protected space. Provided the smoke or flame is within the FoV and range of the camera, by analysing the images produced from a live video feed, sophisticated analysis algorithms can detect when a fire is present. This means that, unlike OBSDs and ASDs, video fire detectors do not need to be in the proximity of fire products to detect it, as they can effectively “see” the smoke or flames – leading to a quicker response. Of course, this does rely on a clear line of sight between the detector and fire, with such systems typically being sited high up to ensure a clear view of the volume being protected.

There are two types of video fire detector: Video Flame Detectors (VFD) that recognise the flame signature from a flaming fire, and Video Smoke Detectors (VSD) that can identify the presence of moving smoke. Some systems can have both sets of algorithms working independently at the same time.

Despite their increasing use, there is currently no test standard providing a robust set of proven and well researched tests to assess the performance capabilities of VFD and VSD in anticipated service environments. Whilst there is an ISO technical specification for video fire detectors [9] it lacks detail with regards to adequately prescribed test methods for certification purposes. To assess video fire detectors,

sufficiently detailed and well demonstrated benchmark tests for basic performance are required, as well as operational performance tests to verify the absolute detection capabilities of VFD and VSD in real fires.

All known manufacturers of video fire detectors were invited and offered the chance to participate in this research work, as the aim was to develop test methods for assessing all systems on the market. Due to a lack of interest internationally, this work was done in collaboration with interested UK parties who had sufficiently developed their own video fire detectors. With participation also from BRE Global and the FIA, the Video Fire Detector research group was formed.

In order to gain the necessary underpinning knowledge on the performance capabilities of video fire detector systems, the research group aimed to develop test methods in four stages:

- VFD – bench testing
- VFD – full-scale fire testing
- VSD – bench testing
- VSD – full-scale fire testing

Due to the technological differences, separate benchmark tests were required for video smoke and video flame detection. It was anticipated that systems combining both detection methods would require the smoke and flame detection functions to be tested independently, but in the field could be used together to provide the most reliable response.

Whilst a number of different manufacturers of video fire detection systems participated in this study, the system makes and models are not named in this report. Examples of cameras used in video fire detection systems are shown in Figure 2.



Figure 2: Examples of video fire detection system cameras (photos courtesy of Araani, Fike Safety Technology Ltd and NetVu Ltd)

Video flame detection – bench testing

Methodology

Initial trials were performed using the method from the EN 54-10 standard for testing flame detectors, to determine whether the methodology using a flame bench (see Figure 3) could be used or easily adapted to assess VFD. The test uses a methane burner to produce a steady flame. An iris is used to increase the amount of flame that can be viewed through an aperture until the detector, located 1.5 m from the flame, responds. This ensures that the signal generated from the flame source is steady and a repeatable flickering signal is then generated using a chopper that is used to modulate the signal.

The detector, aligned with the centre of the flame, effectively “sees” a flickering flame that, for the purpose of testing, is repeatable in

terms of the frequency of radiation, the peak intensity and modulated frequency. The same detector is tested on a number of occasions, with only the distance between the detector and flame changed (up to a maximum 3.5 m), to give an indication of its repeatability. This small-scale bench test is not intended to represent reality, but to assess the performance of a product in a reliable and controllable way.

The set-up is then fixed, with nothing changed except the distance between flame and detector when testing other detectors. The minimum distance at which a device alarms is referred to as its response. Variations in response to the same set-up give an indication of performance, and thus the detector’s reproducibility.

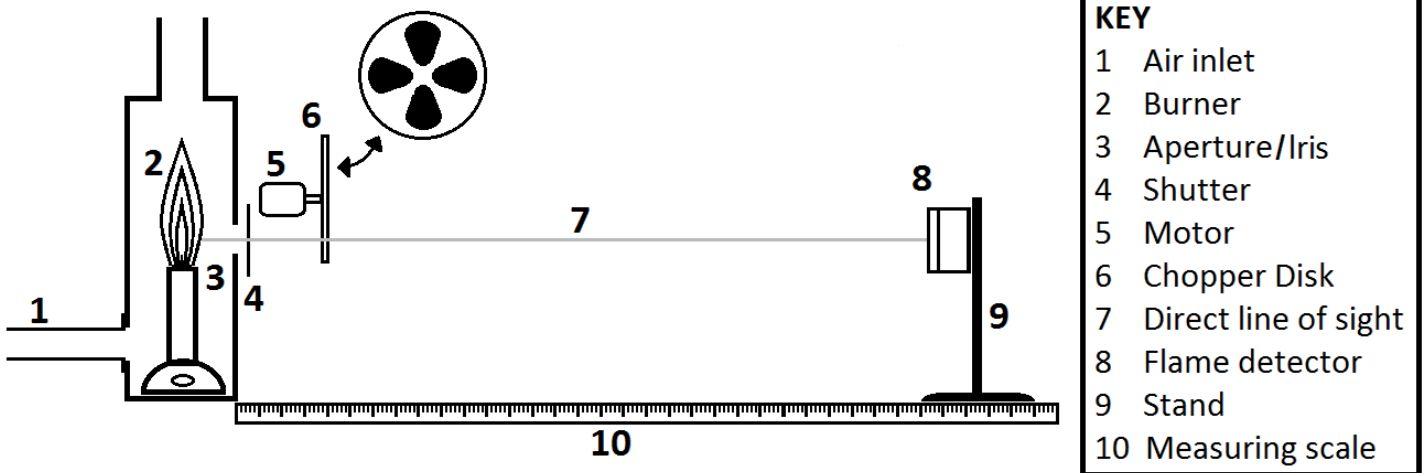

Figure 3: The EN 54-10 test set-up for repeatability and reproducibility testing

Two manufacturers’ VFD were tested using the methodology defined in EN 54-10. Neither produced an alarm response using the exact EN 54-10 test set-up.

For VFD system 1 the EN 54-10 test set-up was modified slightly by switching off the chopper so that a constant flame was visible through the aperture with the iris fully open.

VFD system 2 would not respond to the EN 54-10 flame when viewed through the aperture as there were no “real” edges to the flame. Variations using a Bunsen burner flame were attempted, but due to effects such as turbulence and flame size variations, the flame was

too erratic and did not lead to a repeatable reference flame. However, VFD system 2 responded to a video of a flame more consistently, so a 20-second video was made of the Bunsen burner flame and played in a loop. This produced a better (but still variable) response. This video was analysed further and a segment was taken from it that was 0.76 seconds long. In this segment the flame started from a minimum size, reached a maximum and returned to a similar minimum size. The segment was pasted into a video multiple times so that the sequence was ~20 seconds long. This final sequence was 1280 x 720 pixels in frame size and was repeated when played. The modified EN 54-10 test set-up was used with a recording of this modified video played on a laptop screen and presented to the VFD system 2 cameras.

Results

The eight VFD system 2 cameras were set with a default 60Hz refresh rate and 0 sec "delay to fire" resulting in an immediate alarm response as soon as the fire was detected. The test distances were varied in 5cm gradations. Table 1 shows the response of the eight

VFD cameras tested using the EN 54-10 method, but with the looped video of a flame. The response point is the minimum distance at which the specimen responded with an alarm signal, and the maximum, minimum and mean distances are referred to as Dmax, Dmin and Dmean respectively.

Reproducibility – VFD system 2				
Sensitivity setting: Medium setting				
Specimen No.	Response point (mm)	Designated Dmax & Dmin	Ratio 1 Dmax : Dmean	Ratio 2 Dmean : Dmin
1	2500		1.09	1.06
2	2300			
3	2200	Dmin		
4	2550	Dmax		
5	2250			
6	2250			
7	2250			
8	2400			
Dmean = 2337.5 mm				
Requirements of EN 54-10:2002: Dmax : Dmean ≤ 1.15, Dmean : Dmin ≤ 1.22				

Table 1: Responses from the eight system 2 VFD tested to the looped video

The responses from the 8 system 2 cameras fall within the requirements taken from EN 54-10 that were considered appropriate for testing a VFD camera to a projected looped video of a flame. Similar observations were made of VFD system 1 using the EN 54-

10 set-up with the chopper switched off. The max:mean ratios and mean:min ratio limits from EN 54-10 are 1.15 and 1.22 respectively for both systems. For VFD system 1 these were identified as 1.11 and 1.16, and for VFD system 2 1.09 and 1.06, respectively.

Video flame detection – full-scale fire testing

Methodology

In EN 54-10, the full-scale fire tests are performed by exposing eight flame detectors to radiation from two types of test fires at known distance, d , to determine if the detectors are capable of responding as required (see Figure 4). These test fires are placed at either 25, 17 or 12 m from the flame detectors under test that respectively correspond to classes 1, 2 or 3. Eight flame detectors are mounted on a support with their optical axes in the horizontal plane and at a height of $1500 \text{ mm} \pm 200 \text{ mm}$, and are connected to their supply and monitoring

equipment. Two test fires are performed:

- 1) ~500 ml of n-Heptane (>95% purity) with approximately 3% toluene (>95% purity) by volume burned in a square tray made from 2 mm thick sheet steel, with dimensions 330 mm x 330 mm x 50 mm deep.
- 2) ~1500 ml of methylated spirit (>95% purity) containing at least 90% ethyl alcohol by volume burned in a square tray made from 2 mm thick sheet steel, with dimensions 500 mm x 500 mm x 50 mm deep.

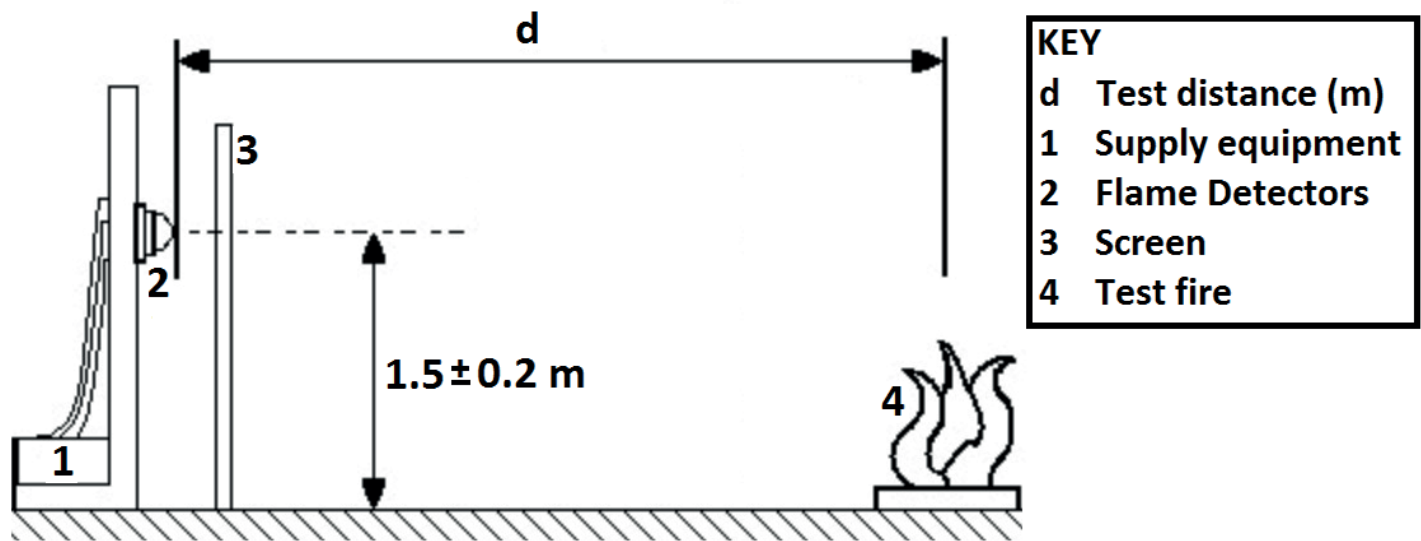

Figure 4: The EN 54-10 test set-up for fire sensitivity testing

Once the fuel is ignited the detectors are physically screened from the fire for 60 seconds and the screen is then removed, after which all eight specimens are expected to produce an alarm signal within 30 seconds.

The VFD were assessed by performing the same two fire tests (see the example in Figure 5) using the same fuels and trays. However, as the VFD can detect fires at much greater distances than flame detectors approved to EN 54-10, the tests were performed with test distances >25m.



Figure 5: n-Heptane test fire in the 500mm square steel tray

Using a 100 m long concrete strip on the BRE site over a two-day period, the distance between the VFD and fires was varied to investigate the relationship between distance and response time. This methodology differed from EN 54-10, in which the separation of fire and detectors is limited to a maximum of 25 m. Also, a screen was not used as the VFD are required to monitor the protected area for a period of time before ignition. The initial sequence of the video provides the benchmark for the analysis that is subsequently performed by the VFD.

Two manufacturers provided one VFD each that were installed in close proximity to one another. They were set-up at one end of a 100 m long concrete strip, permitting tests to be performed up to this distance. To protect manufacturers' VFD performance data from being misused or misrepresented, the systems are referred to anonymously and the manufacturer, model, lens used, etc. are not identified in this report. Both VFD systems were tested at the default sensitivity setting and with a zero-time delay to fire. VFD system 1 was set to a 35m range setting – previous testing to a UL video fire detector standard having indicated that it would detect fires at this distance. VFD system 2 was configured with a similar sensitivity.

The tests were performed over two days with ten tests (5 n-Heptane and 5 methylated spirits) on the first day and eleven tests on the second day (10 n-Heptane and 1 methylated spirits). During the first day of testing it was observed that the responses to both test fires were similar and so, as the n-Heptane required much less fuel, its use was favoured on the second day.

Results

The two VFD systems tested had a similar response to all the test fires in terms of going into alarm condition at similar times, but the results from only one are presented here as the data from the other was

subsequently lost. The responses to all 21 fires are shown in Figure 6 by plotting the distance between the VFD and test fire against the response time. The upper and lower limits have been defined by joining the minimum and maximum points respectively on the chart.

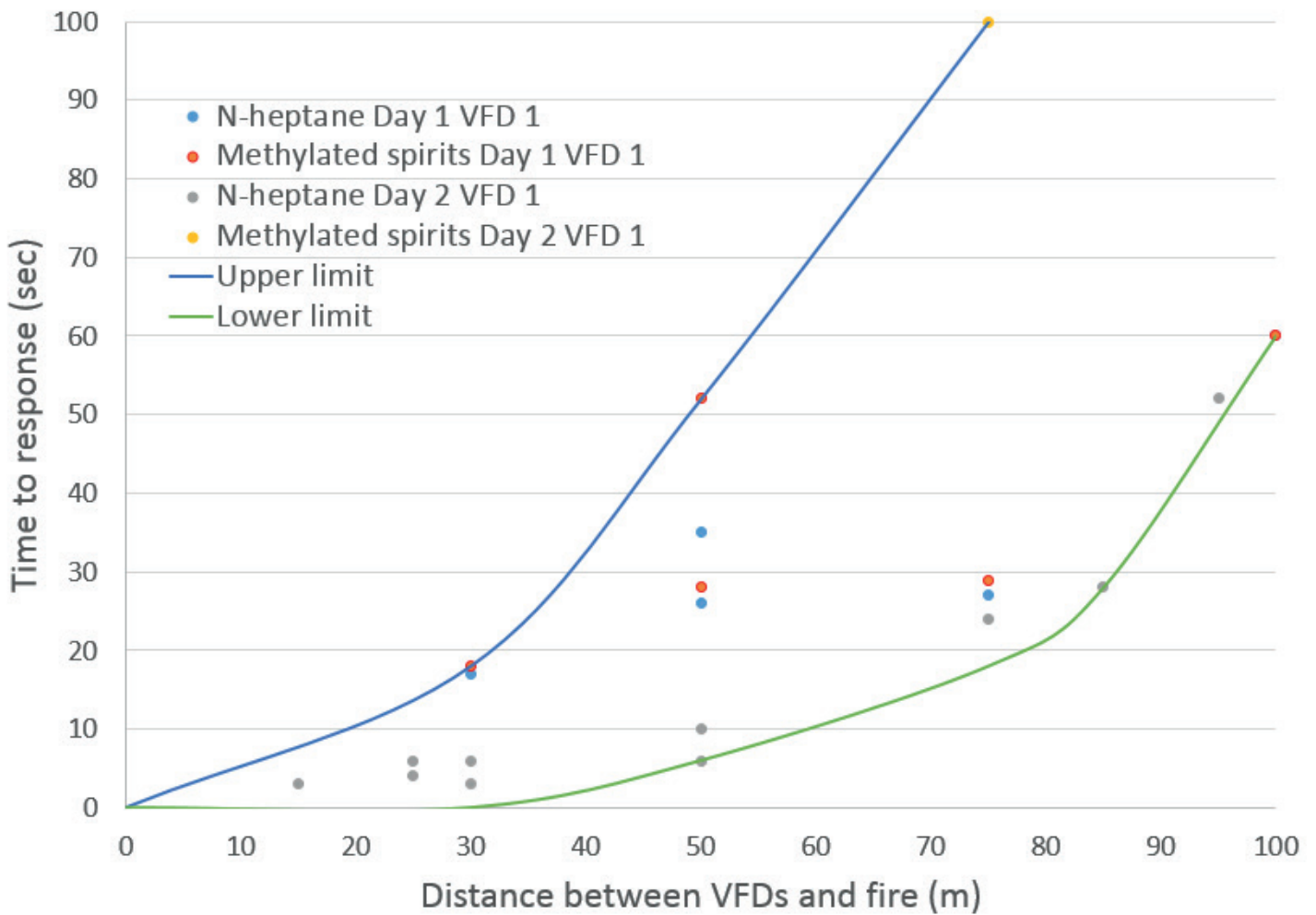

Figure 6: VFD responses to the 21 fire tests performed at different distances

Generally, it is observed that as the separation distance increases the response time increases. As the separation distance increases the variability in the response times greatly increases.

Point-type flame detectors are required to alarm within 30 seconds of exposure to the fire. It appears that at the 35m setting, VFD 1 would repeatedly detect fires before 30 seconds, so achieving a comparable performance when assessed against the exact set-up and test fires as those in EN 54-10.

Both test days were slightly windy with gusts on the second day reaching 18 mph. The presence of wind tends to make the fire lean and, depending on its direction, can lead to either a reduction or increase in the amount of signal received by the VFD. This may explain the variability in the results to the same test fire at different times and on different days – further work would be required to confirm this.

It would be advisable that such tests are performed in wind conditions that do not affect them, or preferably indoors.

Video smoke detection – bench testing

Methodology

Fundamentally, VSD systems monitor the changes in pixels (between individual images taken from a video sequence) and their attributes, to identify when the changes represent a sufficient growth in smoke plume to indicate a fire. To develop a test method, a simple metric was needed to reflect the growing amount of smoke within a video sequence, which could be used as a measure of the VSD's response.

The EN 54 series of standards for fire detectors uses a linearly increasing stimulus to assess alarm response. Ideally the methodology used for assessing VSD also needs to have a linear growth, with the smoke from the fire gradually increasing. A metric that reflects the increase in smoke and incorporates the pass limits used in EN 54-7 [10] to assess smoke detectors, could measure the performance of VSD and establish acceptance criteria, using an existing accepted test methodology and requirements.

During initial trials it was observed that background changes in ambient light levels (from sunlight or shadows) affect the images observed by the camera and therefore need to be controlled. If the environment is controlled to exclude such external interference, the metric will reflect the change solely due to the smoke from the fire. It can then be used to:

- identify whether the changes within a sequence of images could be quantified and considered a linear growth,
- determine at what value of the metric the VSD should respond.

After a number of trials, a metric was identified that corresponded with the amount of pixel change within a series of images. This was the root mean squared error (RMSE) deviation, which is the most basic form of how VSD work. This deviation is quantified by calculating the colour difference between initial and subsequent frames of a video by noting the changes in the colour attributes of each individual pixel from the initial image. These individual changes are squared, summed and then averaged over all pixels of the image and then the square root of this is taken and reported as a percentage change. The more the image changes throughout the dynamic range of the colour attributes

for each pixel, the greater the reported change. For example, if a video sequence starts off with the first frame completely white, which gradually gets darker until the final frame is completely black, this would correspond to a 100% RMSE change.

A methodology was developed to generate RMSEs which comprised of the following steps:

1. A video of a smouldering fire (wood or cotton based) is taken in a fire test room in which all other conditions are controlled, and in which the background contrasts with the smoke colour.
2. Using specialist software, the video file is split into a sequence of frames (images) e.g. every 5 seconds. The first frame of this sequence is taken as the reference and each subsequent frame is compared to that reference.
3. Using another specialist software tool, the images are processed by an algorithm that performs an RMSE deviation analysis of subsequent images from the first reference image. This is then output in a CSV file as the changes in RMSE with time.
4. Once a video sequence that produces a linear growth of RMSE is identified, this is played back to a VSD system using an image source such as an LCD monitor. Provided the full FoV of the recorded video sequence is displayed on the monitor, and the monitor is within the FoV of the VSD under test, the image sequence received by the VSD also has a linear growth which can be used to assess when it responds. This presumes that the refresh rate of the monitor does not interfere with the refresh rate of the camera.

Figure 7 shows the RMSE growth of a smouldering cotton fire that was run in the BRE fire test room and recorded with a Nikon D3100 camera with an 18-55 mm lens. The image analysis was performed using the steps described above. It can be seen that at the start (0-50 seconds) there is a jump in the recorded RMSE. This is due to the camera being started and the operator exiting the room. For the purposes of testing, this initial step has to be compensated for so that the RMSE is shifted to 0 just before the fire (~200 sec).

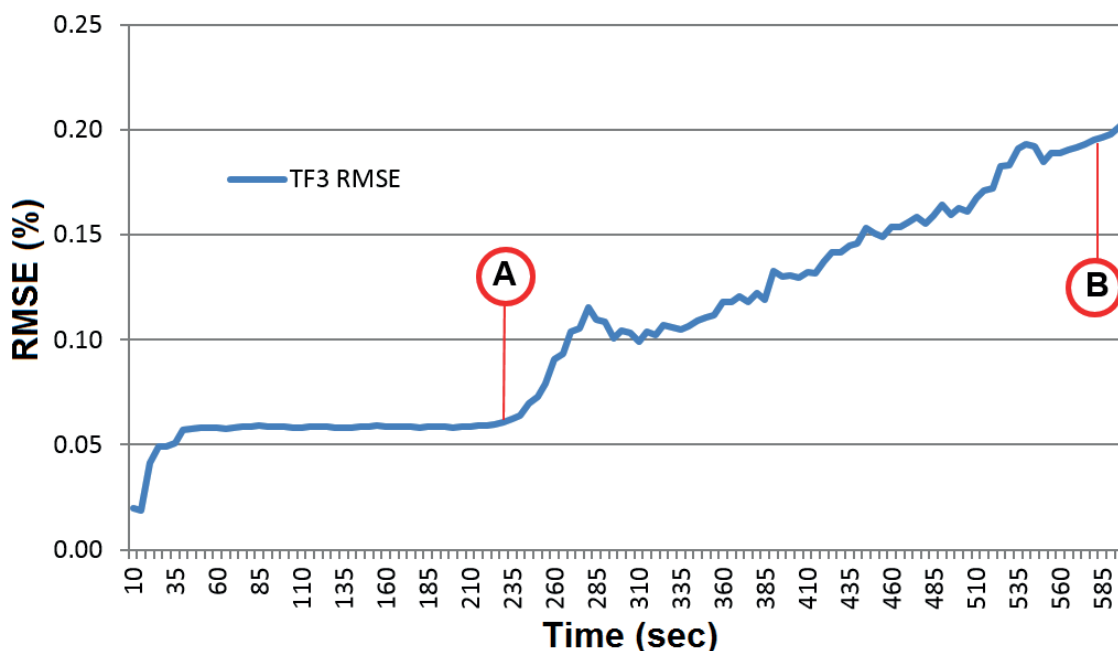

Figure 7: RMSE analysis of a TF3 (smouldering cotton) test fire

Point A in Figure 7 refers to the point at which the image content started to alter (see Figure 8 - LHS image). Point B in Figure 7 refers to

the point at which the image has changed due to the smoke from the fire (see Figure 8 - RHS image).



Figure 8: RMSE analysis of a TF3 test fire before the test (LHS) and during (RHS)

As can be seen from the example in Figure 7, there is a steady growth of RMSE in this video sequence, so when this is played back to a VSD under test it should “see” the same growth in RMSE. As there is a gradual increase of RMSE, the response of the VSD system can be determined by noting the time into the video at which it responds, and using the data from Figure 7 to equate this to an RMSE response (in %).

A number of attempts were made in the BRE fire test room to generate a video with a linear increasing smoke level, and a background colour and ambient lighting level that would provide the required contrast with the smoke. A suitable test fire video was generated using a high definition camera approximately 9m away from the fire (see Figure 10). The fire was based on an EN 54-7 TF2 (smouldering wood fire).

BRE’s digital products team developed a bespoke software package (see Figure 9) that saved time and effort by completing the image analysis (steps 1-3 described earlier) automatically with minimum user interactions. This allows a video to be selected, an initial frame to be picked (from which all subsequent analyses would be performed) and the interval period for selection of subsequent images (e.g. every 5 seconds). The results would then be output as a CSV file that, using Microsoft Excel, could be used to produce a graph.

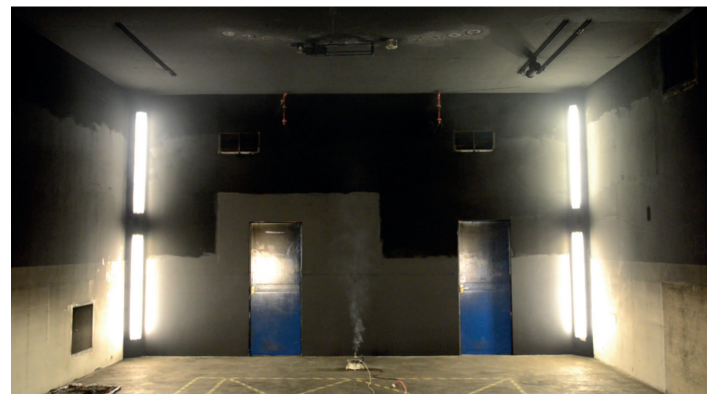

Figure 10: Test set-up in BRE fire test room

The RMSE analysis of this video is shown in Figure 11.

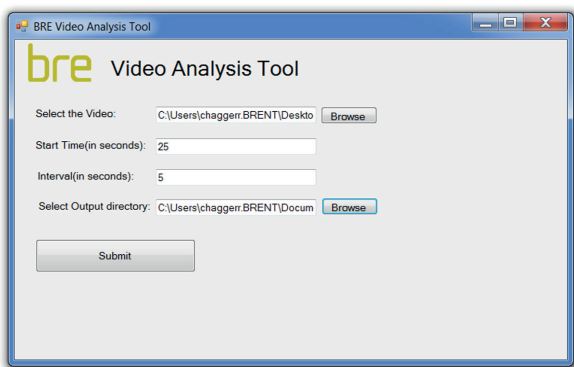

Figure 9: BRE Video Analysis Tool

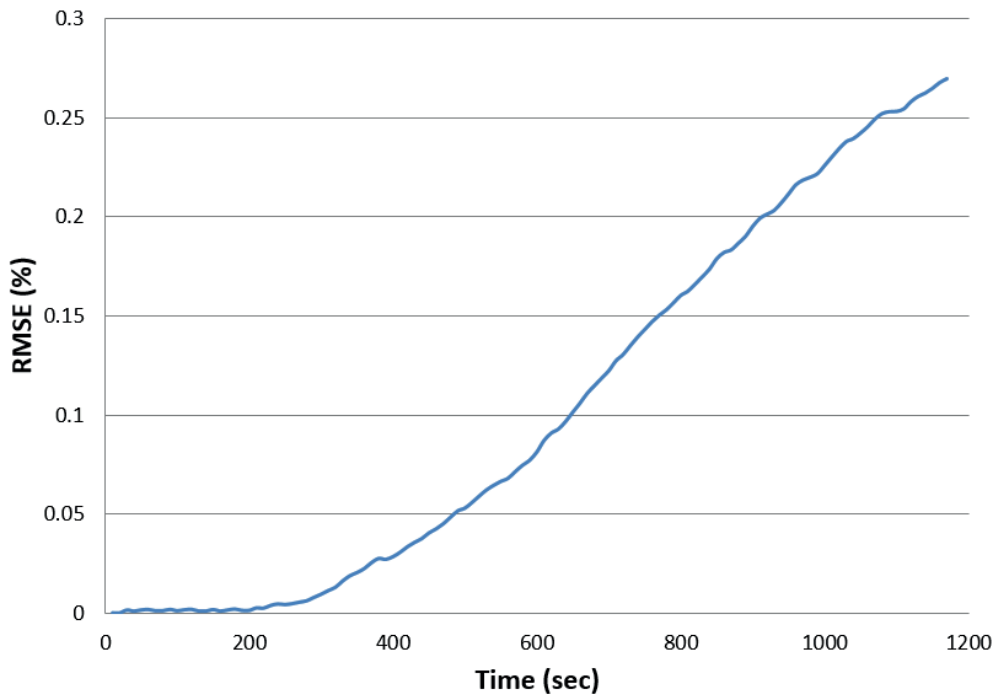

Figure 11: RMSE analysis of a reduced TF2 fire in BRE fire test room

As can be seen, this growth is as close to a linear growth as can reasonably be expected from a fire.

When this video sequence was played back to the VSD systems, they did not produce a consistent response. Upon investigation it was found that such factors as the ambient light levels, shadows produced by people moving in the room, and the initial dwell time period for which VSD systems were exposed to the sequence prior to the test, all needed to be controlled. Once these were controlled the VSDs responded well to the projected video with the default settings and specific characteristics of the monitor used. It would be expected that for testing purposes the monitor used including the settings would remain consistent throughout a testing programme. Figure 12 shows the final set-up used for the tests – the lights in the room are off (note the photo was taken with the lights on) and the only change observed by the cameras is the change in the video sequence that it “sees”.

Before a reproducible response (between VSD) could be achieved, a repeatable response (of one VSD to the same test method) was confirmed as a provisional step, to demonstrate that the test methodology was being applied consistently.

Two VSD systems from different manufacturers were used for repeatability and six VSD from each of the manufacturers were used to assess reproducibility. Due care was taken to ensure the set-up (between VSD) and the field of view were matched. After 5 minutes of viewing the initial frame, the video clip was started from the beginning and the response times at which the VSD responded were noted.



Figure 12: The video of a developing fire played back to the VSD systems under test

Results

The time of alarms were recorded and, using the data from Figure 11, the RMSE values were determined. The maximum and minimum

responses (and where relevant the mean RMSE) were calculated to identify the relevant ratio requirements of the test, for comparison with the ratio requirements for existing EN 54 standards.

Repeatability				
VSD system 1, sample 1 (smoke plume)			Sensitivity setting: Medium setting	
Test No.	Response time (min:sec)	RMSE (%)	RMSE Max/ Min	Max:Min
1	5:40	0.0187	MAX	1.380
2	5:31	0.0163		
3	5:26	0.0148		
4	5:30	0.0161		
5	5:32	0.0166		
6	5:22	0.0136	MIN	

Table 2: Results from repeatability tests on VSD system 1, sample 1 to smoke plume

The repeatability ratio requirement for repeatability (over 6 measurements) from smoke detector standards (EN 54-7 and EN 54-20 [11] for aspirating smoke detectors) are Max:Min \leq 1.6. VSD system 1, sample 1 was able to produce two independent alarm responses

from the rising smoke plume and smoke present at ceiling. Two different samples from VSD system 2 were reviewed and the following Max:Min ratios were observed:

VSD identify / response type	RMSE Max:Min
VSD system 1, sample 1 -response to rising smoke plume	1.380
VSD system 1, sample 1 -response to smoke at ceiling	1.024
VSD system 2, sample 1	1.048
VSD system 2, sample 2	1.194
Requirement	\leq 1.6

Table 3: Summary of Repeatability results for VSD

In terms of the reproducibility, the ratio requirements from smoke detector standards (EN 54-7 and EN 54-20) are Max:Mean \leq 1.33 and Mean:Min \leq 1.5. For the two systems, six different samples were tested

and, as an example, the results for VSD system 1, sample 1 (response to rising smoke plume) are shown in Table 4.

Reproducibility					
VSD system 1, sample 1 (smoke plume)			Sensitivity setting: Medium setting		
Specimen No.	Response time (min:sec)	RMSE (%)	RMSE Max/ Min	Max:Mean	Mean:Min
1	5:30	0.0161		1.176	1.203
2	5:15	0.0121	MIN		
3	5:17	0.0124			
4	5:25	0.0145			
5	5:27	0.0151			
6	5:34	0.0171	MAX		
RMSE mean = 0.0146%					

Table 4: Summary of Reproducibility for VSD system 1, sample 1 (smoke plume)

For all the systems tested Table 5 provides a summary of the findings and it can be observed that all met the ratio requirements from the EN 54 standards.

VSD system and samples	RMSE Max:Mean	RMSE Mean:Min
VSD system 1, samples 1-6 (response to rising smoke plume)	1.176	1.203
VSD system 1, samples 1-6 (response to smoke at ceiling)	1.070	1.019
VSD system 2, samples 1-6	1.045	1.031
Requirement	≤ 1.33	≤ 1.5

Table 5: Summary of Reproducibility results for VSD

The exercise of producing videos with an appropriate growth of smoke, performing RMSE analysis and then projecting videos back to cameras under controlled conditions, has proven to be an acceptable method of determining VSD responses. The responses can then be used to assess the performance of the VSD and confirm whether the

requirements currently used in the EN 54 smoke standards are met.

All systems tested were within the limits of EN 54-7 for assessing repeatability and reproducibility, therefore these limits are considered acceptable for the purpose of assessing VSD.

Video smoke detection – full-scale fire testing

Methodology

It was proposed that testing white smoke against a black background and black smoke against a white background would serve to demonstrate the capability of a VSD to respond to smoke from different fires. The test fires TF2-TF5 from EN 54-7 were chosen; the TF2 (smouldering wood) and TF3 (smouldering cotton wick) fires produce white smoke, and the TF4 (flaming polyurethane) and TF5 (flaming liquids) fires produce black smoke.

Testing the VSD in a consistent manner was challenging for many different reasons and after a number of trials the variables contributing to error and uncertainty in the conditions were identified, along with details of how to overcome them. These are summarised below:

- The control of ambient light was achieved by testing during the night at the BRE Hangar (40 m long, 10 m high (pitched roof) and 20 m wide) in Middlesbrough. The hangar contained a number of skylights that were not easily accessible, so by performing tests at the night there was no contribution to measured RMSE from sunlight.
- Cross flows in the space were controlled by sealing all gaps larger than 10mm with stone wool.
- The use of a chimney and chimney cap (see Figure 13) prevented reflections from the fire falling onto the background and contributing to the measured RMSE.
- A number of different backgrounds were used. It was noted that whilst not observable to the naked eye, a tarpaulin sheet was moving due to small air currents and this was leading to contributions to the measured RMSE. In the final iteration of testing a painted screen (made of 6 plasterboard sheets) was used to control this.
- A large extractor in the ceiling helped to purge the hangar of smoke at the end of the test.

The final arrangement used for the testing is shown in Figure 13. Note that there was a front face to the chimney that prevented direct light from the fire reaching the cameras.

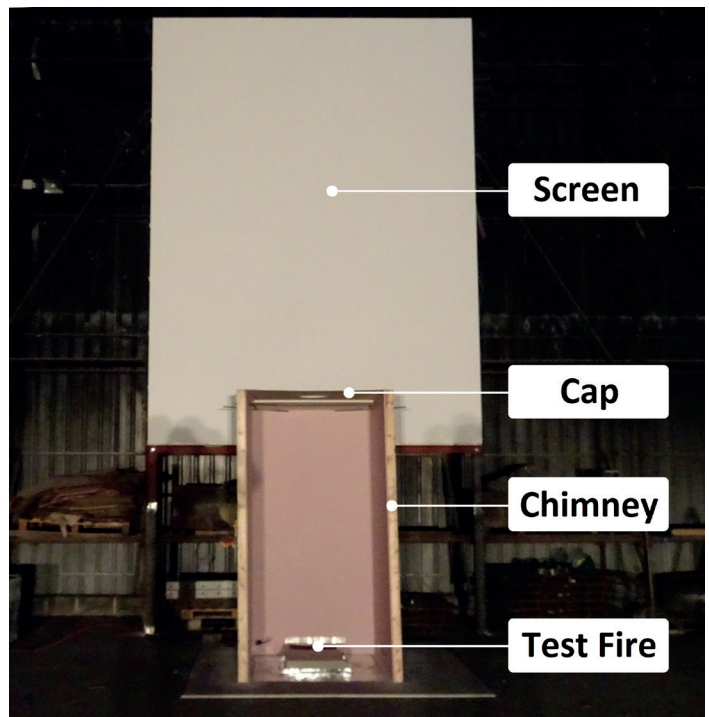

Figure 13: The arrangement of test fire, chimney and background screen during the fires

The screen was painted white for the first set of test fires, and then matt black for the second series of test fires (performed on the following day).

With all the lights in the fire test laboratory switched off the level of illumination present at twilight over the entire surface of the plasterboard screen was less than 1 lux. Four Xenon floodlights were used to produce 21.4 ± 0.3 lux over the surface of the plasterboard screen. It was agreed at the outset of the research work that the fires should be challenging for the technology (see Summary of Findings section for further details).

The reference camera, used to generate the RMSEs, was located 1.5m from the floor and 35m from the screen. Whilst other cameras were used, the methodology for performing the RMSE analysis was always the same and is summarised below.

The optical zoom of the reference camera was used to provide a field of view that encompassed the top of the chimney to above the screen (see Figure 14). The video was started prior to the test and was cropped to include only the area of interest (see Figure 15) and was also “topped and tailed” to only include the test from start to finish. The start being when the fuel was first ignited or when the power to the hotplate was switched on and the end was when smoke production ceased.

Using the BRE Video Analysis Tool (Figure 9) the RMSE was subsequently performed on the video and the RMSE output was generated. By knowing the time of alarm for each VSD, the RMSE could then be determined.



Figure 14: Reference camera FoV

Results

In order to assess the robustness of the methodology for assessing VSD, this work was performed in three stages:

1. study of optimum RMSE resolution – intended to optimise the interval period used to generate RMSE affects during testing;
2. comparison of RMSE outputs from different cameras from two test fires to determine if there is reproducibility between different cameras;
3. check of the repeatability of the results obtained from TF2-TF5 fires.



Figure 15: Cropped area from video sequences used for RMSE analysis

A summary of the findings from each stage is presented in the sections below, and in the final section a summary of VSD responses to all of the test fires is given.

OPTIMUM RMSE RESOLUTION

The RMSE analysis was performed for TF4 #3 at X= 2, 5, 10 and 20 second intervals and are presented in Figure 16.

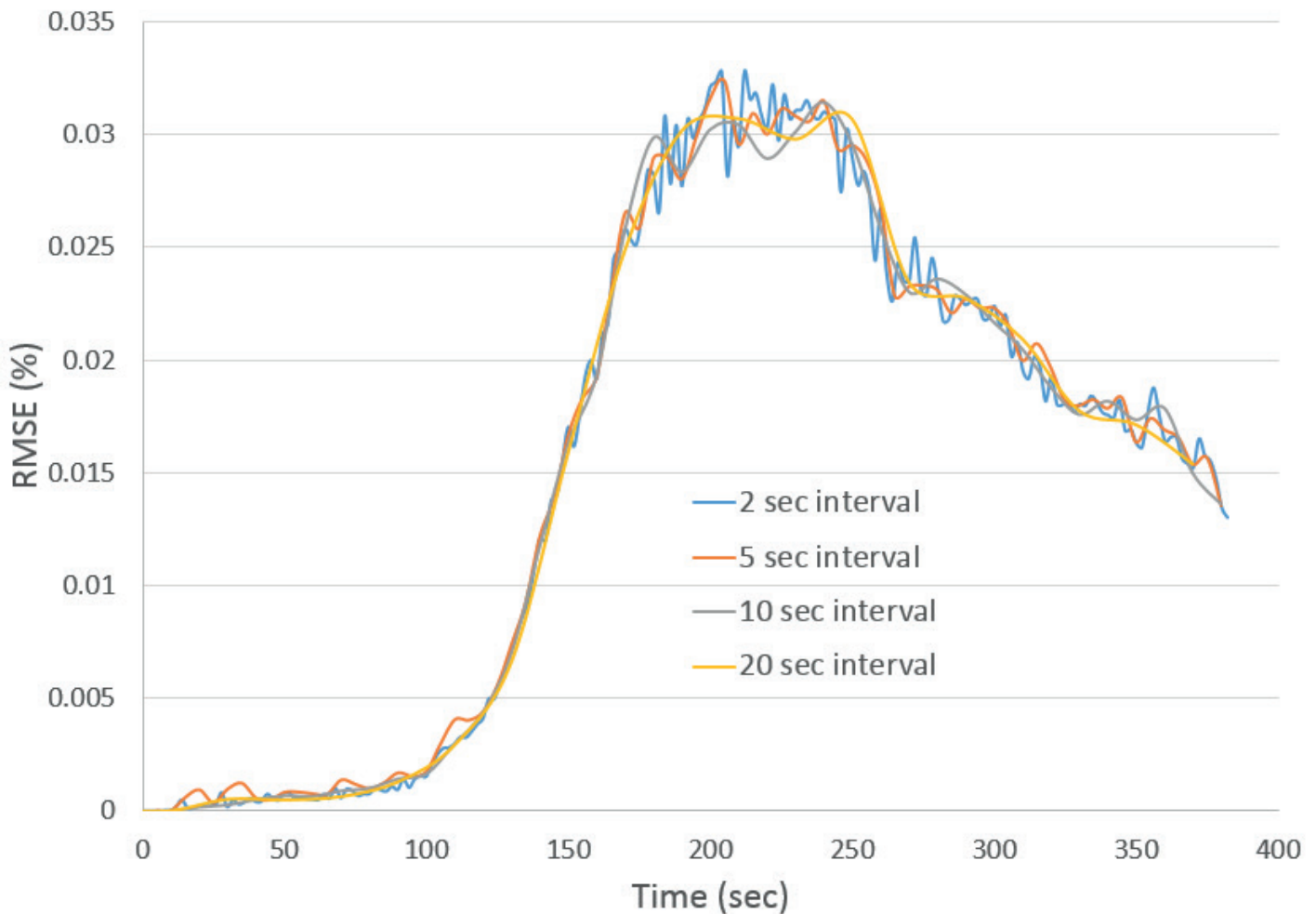

Figure 16: RMSE outputs for TF4 #3 fire at different periods of resolution

It is evident that lower interval time resolutions provide more detailed data, and that longer time intervals provide a smoother curve which is not necessarily representative of how the smoke changed with time. Whilst it would be ideal to have the highest resolution, and perhaps perform the analysis every second, the time taken for the video analytics software to process the data significantly increases. A resolution every 5 seconds provided sufficient detail without loss of information, and the entire RMSE analysis could be performed reasonably quickly.

RMSE OUTPUTS FROM DIFFERENT CAMERAS

Three reference cameras were used to record the footage for two different test fires, to identify whether different cameras in the same locations produced similar outputs of RMSE. A brief study into this was performed using, together with a reference camera, two additional lower specification cameras, reference two and reference three, with capabilities as shown below:

- Reference camera 1920x1080 frame rate 50 frames/sec, total bit rate 26758kbps
- Reference two 1280x720 frame rate 29 frames/sec, total bit rate 9050kbps

- Reference three 1920x1080 frame rate 11 frames/sec, total bit rate 457kbps

Reference three was located 3 m above the floor (to see what effect this had), which was higher than the other two that were located 1.5 m from the floor and were close to each other. All of the reference cameras that were used to produce the RMSEs were located 35 m from the screen.

The RMSE profiles generated from all three cameras are shown for one of the test fires TF4#1 (Figure 17), which were both performed using a white background.

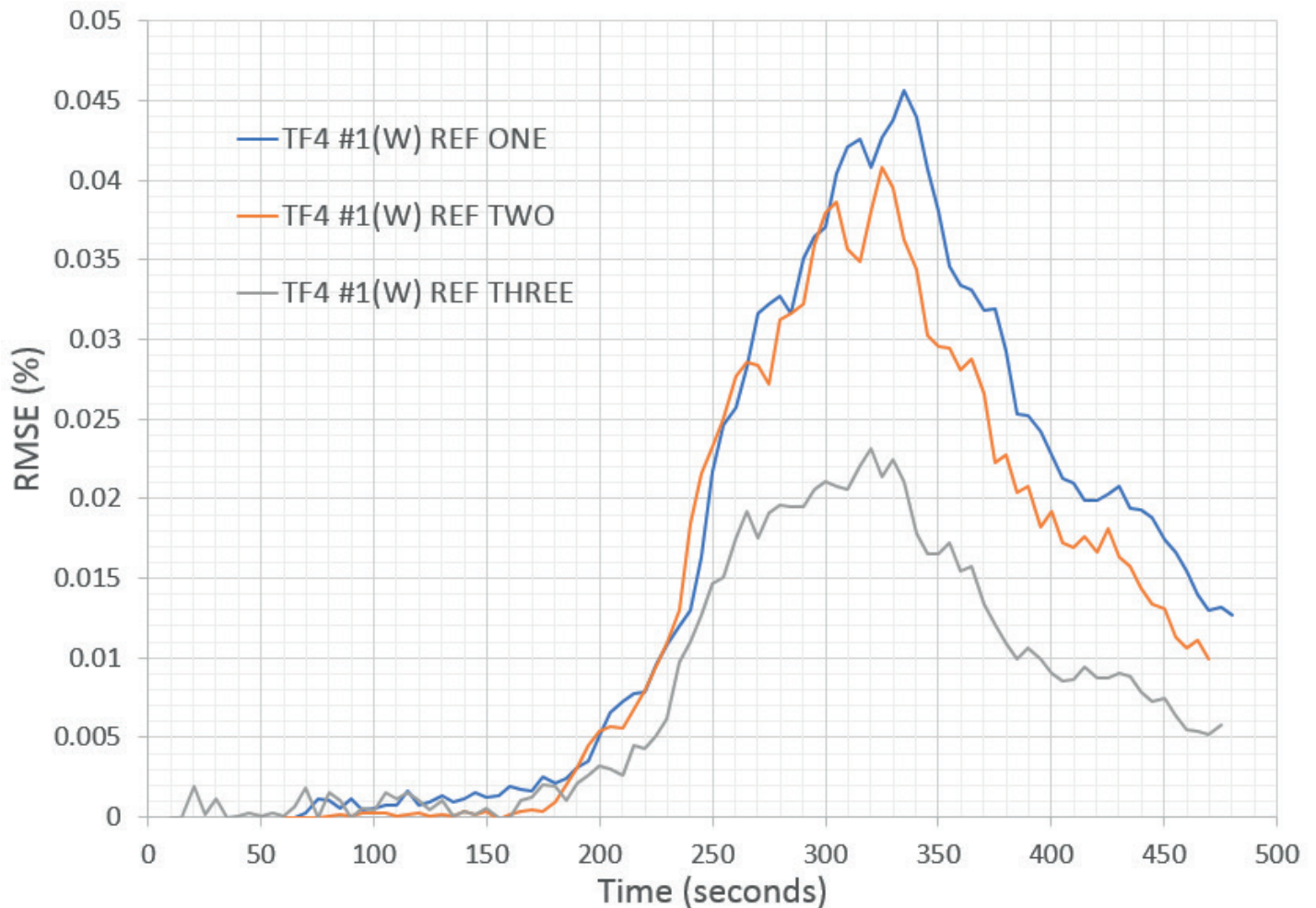

Figure 17: Profiles of RMSE from three cameras for TF4#1

What is evident from Figure 17 is that all three cameras respond in synchrony, generally going up and down together. This demonstrates that all cameras are seeing similar things and the RMSE reflects the changes in smoke density as the fire develops. What is not so clear is why the magnitude of the RMSE is not the same for all three.

Reference three was installed approximately 1.5 m above the other two cameras. The observed difference may be due to parallax and the resulting difference in images that would be expected between the two positions.

Additionally, this difference in RMSE may also be due to the exact way in which each camera converts the luminance on the sensor to a value in the range 0-255, as well as how the camera reports values in absolute black and white conditions. Combined, these two effects may cause RMSEs to differ significantly between cameras, which would imply that an initial calibration and post-correction to align RMSEs from different cameras may be required.

Further work with different and, exactly the same, models of reference cameras is recommended to understand how this variability between these reference cameras can be controlled.

REPEATABILITY OF THE TF2-TF5

The fuels specified for TF2-5 tests in EN 54-7 were modified to produce sufficient smoke for the purposes of testing VSD. For the TF2 test, 19 beech wood sticks were placed on a TF2 hotplate set to 205v AC that gradually warmed the hotplate to a temperature of 600°C. For the TF3 140 test, cotton wicks were heated at the base until they were smouldering. For the TF4 flaming plastics test, five polyurethane mats were placed on top of each other and were remotely lit using an ignition coil. For the TF5 flaming liquids test, 800ml heptane and 40ml Toluene were placed in a 330 mm x 330 mm x 50mm tray and remotely lit using an ignition coil.

Fifteen test fires were performed in total, seven on the first day against a white background and eight on the second day against a black background. On the first day just before the eighth test, which was TF3 #1, the lights in the hangar overheated and tripped the electrics and therefore this test had to be abandoned.

The RMSE analysis was performed as described previously, and as an example the output results from all the TF4 fires, post analysis, are shown in Figure 18. In the legend, the number at the start is the test number and the letters in brackets indicate the colour of the background screen.

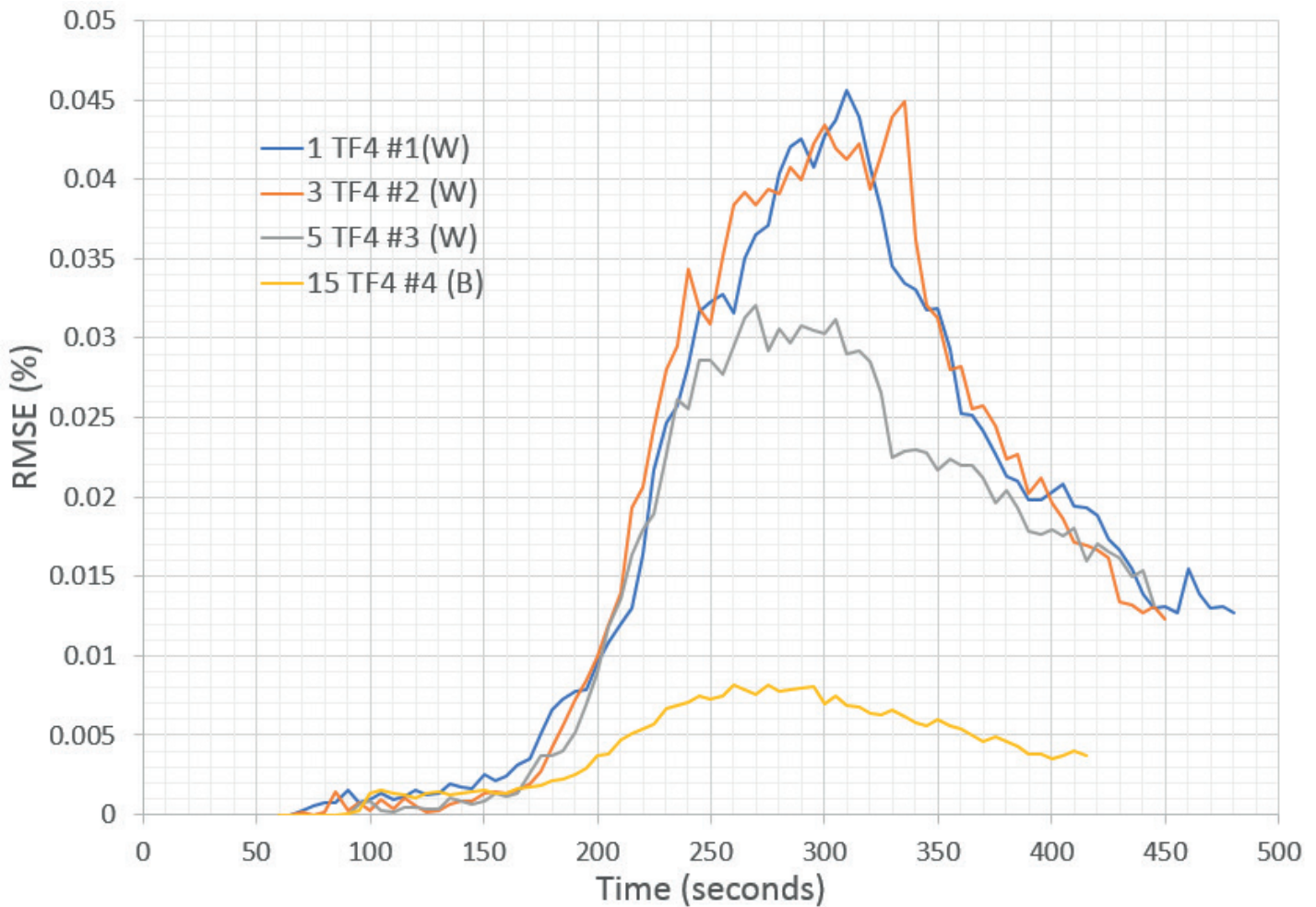

Figure 18: Profiles of RMSE from the reference cameras for all the TF4 fires

From graphs of the fires, general observations were made such as:

- The TF4 fire demonstrated a good level of repeatability on white backgrounds.
- The contrast between the black smoke and the white background led to RMSEs as high as 0.045% being observed.
- As well as observing the smoke against the background, the video sequences also include the shadow of the smoke on the background, thereby enabling more movement to be observed and resulting in greater values of RMSE. As this phenomenon is likely to be observed by the VSD it was not considered to have introduced any bias to a testing procedure.
- The rate of rise of this fire was quite fast, taking around 2.5 minutes to reach a peak from when the smoke first starts to increase. This could be slowed down, if needed, by spreading the fuel out.
- The TF4 fire against a black background provided a growth and peak that appears to be around 24% of the average RMSE of the three TF4 fires against a white background.
- Due to the lack of contrast between the white smoke and the black non-reflective background, the TF3 fire struggled to reach 10% of the RMSE recorded for TF4 and TF5 fires against a white background.
- The fires demonstrated a reasonable level of repeatability.
- The TF2 fire against a white background provided a RMSE growth that was around 43% of the average of the three TF2 fires against a black background.
- The rate of rise of these fires was very good, rising gradually (over ~10 minutes) as the test progressed.

Similar observations were made during the other flaming TF5 fires. For the TF2 and TF3 test fires the key observations are shown below:

SUMMARY OF VSD RESPONSES

The VSD demonstrated an ability to respond to the fires that was dependent on the sensitivity, lens and camera type specified by the manufacturer. It was clear that some VSD struggled to detect the fires at low ambient light level, due to the lack of contrast between the smoke and the background. However, in summary, without naming manufacturers or models of VSD tested, the following responses were observed:

- The VSD from the three manufacturers responded 92%, 62% and 21% of the time during the 15 fires for all the detectors tested.
- There were positive responses from the VSD to black smoke against a white background and white smoke against a black background, which were 59% and 58% respectively.
- There were positive responses from the VSD to white smoke against a white background and black smoke against a black background, which were 50% and 55% respectively.

An example of a VSD system responding to the smoke from a TF2 fire (white smoke) with a white background is given in Figure 19.

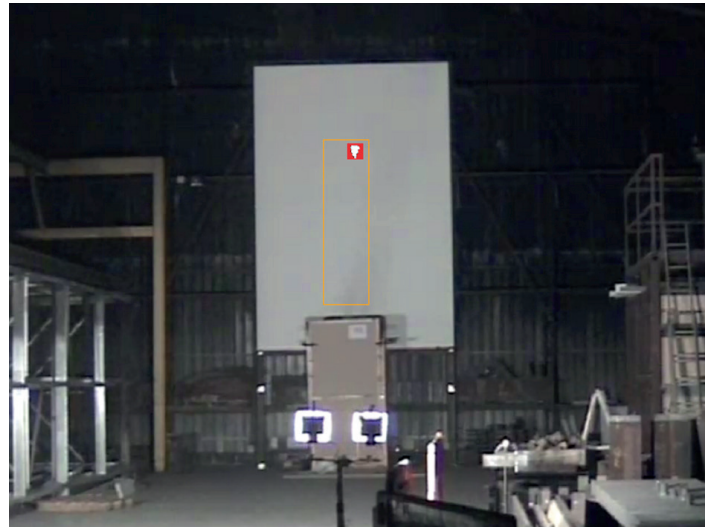

Figure 19: Screenshot of a VSD system responding to a test fire (photo courtesy of Xtralis)



Figure 20: Test set-up with the black background screen

Summary of Findings

Developing test methods to assess the performance of video fire detectors led to some interesting questions being raised, such as what is an appropriate light level at which to perform the fire tests? The research group agreed that the systems should be onerously tested, and this should include a minimum light level. For most VSD systems, operating at around 20 lux is challenging. As the light level increases, the observed contrast is greater and hence a quicker response would be expected. Whilst a test standard could require fire tests to be performed at multiple light levels, this would increase costs with no significant benefit.

A similar view was taken when considering performing fire tests with different colour backgrounds. Many colours of smoke from different materials are possible, depending on whether they are smouldering or flaming. One could perform numerous tests with different contrasting backgrounds to identify whether a VSD responds to all types of smoke with all colour backgrounds. This would be costly with no significant benefit.

A more pragmatic approach was taken in this case. It was proposed that a number of fire tests be performed to validate the basic performance – as has been done in this research work. Then, together with a related CoP for video fire detectors, commissioning tests would be proposed, such as those in the FIA CoP for ASD [12], to be performed on-site. Such an approach ensures that a reasonable number of tests are performed to validate performance, and that commissioning tests on-site give confidence in the ability of the video fire detectors to respond to a broad range of smokes expected in that specific service environment.

This led to a key proposal that, in order to produce a comprehensive standard without making it unnecessarily costly in terms of over-testing, a test standard for video fire detectors should be developed together with an associated CoP.

Video flame detection – bench testing

Testing VFD has proven to be challenging due to the differences in the video flame detection algorithms used to identify when a flame is present. The same test method could not be used to assess the two VFD products investigated in this research, because they used different methods of identifying flame signatures.

Using either a real, steady (un-flickering) flame or a looped video of a flame as a stimulus, and varying the distance of the camera from the stimulus, has proven to be an acceptable method of identifying VFD responses. This can then be used to assess the performance of the VFD and identify whether specific requirements are met. Two different methods were proposed and each was shown to work for one of the two VFD systems tested. However, these may not work for other types of VFD.

The $D_{max} : D_{mean}$ ratios and $D_{mean} : D_{min}$ ratios for VFD system 1 were 1.11 and 1.16 respectively, and for VFD system 2 were 1.09 and 1.06 respectively. The requirements from EN 54-10:2002 ($D_{max} : D_{mean} \leq 1.15$ and $D_{mean} : D_{min} \leq 1.22$) appear to apply for VFD systems and to be satisfactory.

Video flame detection – full-scale fire testing

The results demonstrate that testing VFD with the same set-up and test fires used for point-type flame detectors, delivers comparable results for VFD. Point-type flame detectors are required to alarm within 30 seconds of exposure to the fire. It appears that for the 35m setting of the VFD tested, it would repeatedly detect fires before 30 seconds elapsed. It is therefore proposed that the exact methodology and requirements used for fire sensitivity testing in EN 54-10 are used, and

that all tested samples should alarm at the claimed maximum distance within 30 seconds for both test fires.

When performing the tests outside, consideration needs to be given to the effects of wind and the resulting changes in the fire.

Video smoke detection – bench testing

In order to achieve a reproducible performance between detectors, a pre-requisite was for a repeatable response from the same detector.

In terms of repeatability, the ratio requirements of smoke detector standards (EN 54-7 and EN 54-20) for repeatability (over 6 measurements) are $Max:Min \leq 1.6$. For four different systems tested the $Max:Min$ ratios achieved were 1.38, 1.02, 1.05 and 1.19. It is therefore proposed that the limits from the EN standards are used for assessing repeatability.

In terms of reproducibility, the ratio requirements of smoke detector standards (EN 54-7 and EN 54-20) are $Max:Mean \leq 1.33$ and $Mean:Min \leq 1.5$. For three different systems tested the $Max:Mean$ ratios achieved were 1.05, 1.18 and 1.07, whilst the $Max:Mean$ ratios achieved were 1.03, 1.20 and 1.02. It is therefore proposed that the limits from the EN standards are used for assessing reproducibility.

The exercise of producing videos with an appropriate growth of smoke, performing RMSE analysis and then projecting videos back to cameras under the correct conditions, has proven to be an acceptable method of determining VSD responses. There was no evidence that the refresh rate of the monitor adversely interfered with the refresh rate of the camera.

The responses to the video sequences can then be used to assess the performance of the VSD and confirm whether the requirements currently used in EN 54 series of standards are met.

Video smoke detection – full-scale fire testing

A suitable methodology for generating RMSE profiles of full-scale fires has successfully been developed, and VSD have demonstrated the ability to respond to these. The background conditions have been tightly controlled and use modified TF2 to TF5 fires from EN 54-7.

In terms of the RMSE responses of the four fires against different backgrounds, it was observed that the TF2 fire against a white background produced around 43% of the RMSE when performed with a black background. The TF4 and TF5 fires against a black background produced 24% and 16% respectively of the RMSE when performed with a white background.

The VSD have proven their ability to respond to the small amounts of smoke generated from these fires 35m away. However, further work is required before a final methodology can be proposed for assessing their absolute performance capabilities.

Conclusions

The purpose of this research work was to identify suitable bench tests and operational performance tests for testing VFD and VSD. Suitable test methods have been developed and, where applicable, assessment criteria proposed for both types of detector.

For VFD no single bench test method was identified that could be applied to both VFD types tested, since they appear to use quite different methods to identify the presence of a flame. Therefore, two test methods have been proposed. Assessment criteria taken from the point flame detector standard EN 54-10:2002, appeared to be appropriate and the VFD responded within these limits.

For VFD the fire test methodology used in EN 54-10 was proposed and worked for two different VFD tested. The methodology permits test samples to be located at distances up to 100 m from the two test fires and has demonstrated the ability of VFD to respond with an alarm condition within 30 seconds of ignition.

For VSD a repeatable bench test method was developed that works with both systems tested. This method involves taking a video of a developing fire, calculating the RMSE of a video sequence and projecting this video sequence to the VSD under test. Assessment criteria taken from the point smoke detector standard EN 54-7:2001, appeared to be appropriate and the VSD responded within these limits.

For the VSD fire tests, after many iterations of development a suitable methodology for generating RMSE profiles of fires at full scale has been successfully developed. Many external factors that were contributing to and resulting in errors in the measurement of RMSE have been addressed and resolved. This work has demonstrated the repeatability of the method and some level of consistency in the four test fires. A study of the RMSE resolution has revealed that a period of 5 seconds was optimum for balancing the time taken to perform the analysis, against the resolution required for sufficient detail of the test fires to be recorded.

The VSD have proven their ability to respond to the small amounts of smoke generated from these fires 35m away. However, responses were quite variable with VSD operating with an average 58% success rate for contrasting background fires. Overall these VSD have also responded with ~52% success rate to the more challenging condition of smoke against similar colour backgrounds. However, in order to develop a methodology for assessing absolute performance further work is required to:

- 1) improve the contrast for TF2 and TF3 fires against a white background,
- 2) slightly slow down the growth of the TF4 and significantly slow down the growth of the TF5 fire,
- 3) identify why there is a difference in reported RMSE to the same fire from different cameras located in close proximity to each other.

A key finding is that to produce a comprehensive test standard for video fire detectors, without over-testing the product and incurring excessive testing and approvals costs, a test standard should be developed together with an associated CoP to ensure that the systems are sufficiently tested and are fit for purpose.

A number of the more challenging tests required to assess VFD and VSD have been developed. The methodologies to test them, and criteria taken from existing EN 54 standards, have been implemented and can be used to assess these types of video fire detectors.

The knowledge gained during this research work will support the various standardisation processes and contribute to the future development of related standards and codes. BRE and the FIA are working together with manufacturers of video fire detectors to identify any additional areas requiring research in this respect.

References

1. Wong, A. K. K., Fong, N. K. Experimental study of video fire detection and its applications. *Procedia Engineering* 71, 316 – 327. Department of Building Services Engineering, The Hong Kong Polytechnic University, Hong Kong, China. 2014.
2. Hadjisophocleous, G., Ouyang J., Ding G. and Liu, Z. Study of Video Image Fire Detection Systems for Protection of Large Industrial Applications and Atria.
<https://pdfs.semanticscholar.org/3dc5/a864dfc3cf70f3da00236e35648b0c83ddbd.pdf>
3. Memane, S. E., Kulkarni, V. S. A Review on Flame and Smoke Detection Techniques in Videos. *International Journal of Advanced Research in Electrical, Electronics and Instrumentation Engineering* 4, Issue 2. SKN College of Engineering, Pune, India. February 2015.
4. Chagger, R. 207-14-RM (Report for Milestone 1). Identifying suitable performance tests for assessing video fire detectors. BRE, Watford, Herts WD25 9XX (private report). 30th September 2015.
5. Chagger, R. 207-14-RM (Report for Milestone 2). Identifying suitable operational performance tests for assessing video fire detectors. BRE, Watford, Herts WD25 9XX (private report). 17th February 2017.
6. Chagger, R. P111268. Development of the operational performance tests for assessing Video Smoke Detectors. BRE, Watford, Herts WD25 9XX (private report). 22 January 2019.
7. Chagger, R. Smoke detection in high ceiling spaces. IP15/12 Parts 1&2. IHS BRE Press, Garston, Watford, WD25 9XX. June 2012.
8. EN 54-10:2002 Fire detection and fire alarm systems Part 10: Flame detectors – Point type detectors using an optical light beam. European Committee for Standardisation. Central Secretariat: Rue de Sarsart 36, B-1050 Brussels.
9. ISO/TS 7240-29:2017(E) Fire detection and alarm systems- Part 29: Video fire detectors. ISO copyright office, Ch. de Blandonnet 8, CP 401, CH-1214 Vernier, Geneva, Switzerland.
10. EN 54-7:2001 Fire detection and fire alarm systems- Part 7: Point type smoke detectors. European Committee for Standardisation. Central Secretariat: Rue de Sarsart 36, B-1050 Brussels.
11. EN 54-20:2006 Fire detection and fire alarm systems- Part 20: Aspirating smoke detectors. European Committee for Standardisation. Central Secretariat: Rue de Sarsart 36, B-1050 Brussels.
12. Fire Industry Association Code of Practice Issue 3. Design, Installation, Commissioning & Maintenance of Aspirating Smoke Detector (aspirator) Systems. Fire Industry Association, Tudor House, Kingsway Business Park, Oldfield Road, Hampton, Middlesex TW12 2HD, UK. February 2012

BRE Trust

Watford, Herts
WD25 9XX

T +44 (0)333 321 8811
E enquiries@bre.co.uk
W www.bre.co.uk

BRE Trust

The BRE Trust uses profits made by BRE Group to fund new research and education programmes, that will help it meet its goal of 'building a better world together'. The BRE Trust is a registered charity in England & Wales:

No. 1092193, and Scotland: No. SC039320.